



Sun™ StorEdge CompactPCI Dual Fibre Channel Network Adapter Installation and User's Guide

Sun Microsystems, Inc.
901 San Antonio Road
Palo Alto, CA 94303
U.S.A. 650-960-1300

Part No. 816-0241-10
March 2001, [Revision A](#)

[Send comments about this document to: docfeedback@sun.com](mailto:docfeedback@sun.com)

Copyright 2001 Sun Microsystems, Inc., 901 San Antonio Road • Palo Alto, CA 94303-4900 USA. All rights reserved.

This product or document is protected by copyright and distributed under licenses restricting its use, copying, distribution, and decompilation. No part of this product or document may be reproduced in any form by any means without prior written authorization of Sun and its licensors, if any. Third-party software, including font technology, is copyrighted and licensed from Sun suppliers.

Parts of the product may be derived from Berkeley BSD systems, licensed from the University of California. UNIX is a registered trademark in the U.S. and other countries, exclusively licensed through X/Open Company, Ltd. For Netscape Communicator™, the following notice applies: Copyright 1995 Netscape Communications Corporation. All rights reserved.

Sun, Sun Microsystems, the Sun logo, AnswerBook2, docs.sun.com, SunSwift, SunVTS, FastEthernet, and Solaris are trademarks, registered trademarks, or service marks of Sun Microsystems, Inc. in the U.S. and other countries. All SPARC trademarks are used under license and are trademarks or registered trademarks of SPARC International, Inc. in the U.S. and other countries. Products bearing SPARC trademarks are based upon an architecture developed by Sun Microsystems, Inc.

The OPEN LOOK and Sun™ Graphical User Interface was developed by Sun Microsystems, Inc. for its users and licensees. Sun acknowledges the pioneering efforts of Xerox in researching and developing the concept of visual or graphical user interfaces for the computer industry. Sun holds a non-exclusive license from Xerox to the Xerox Graphical User Interface, which license also covers Sun's licensees who implement OPEN LOOK GUIs and otherwise comply with Sun's written license agreements.

RESTRICTED RIGHTS: Use, duplication, or disclosure by the U.S. Government is subject to restrictions of FAR 52.227-14(g)(2)(6/87) and FAR 52.227-19(6/87), or DFAR 252.227-7015(b)(6/95) and DFAR 227.7202-3(a).

DOCUMENTATION IS PROVIDED "AS IS" AND ALL EXPRESS OR IMPLIED CONDITIONS, REPRESENTATIONS AND WARRANTIES, INCLUDING ANY IMPLIED WARRANTY OF MERCHANTABILITY, FITNESS FOR A PARTICULAR PURPOSE OR NON-INFRINGEMENT, ARE DISCLAIMED, EXCEPT TO THE EXTENT THAT SUCH DISCLAIMERS ARE HELD TO BE LEGALLY INVALID.

Copyright 2001 Sun Microsystems, Inc., 901 San Antonio Road • Palo Alto, CA 94303-4900 Etats-Unis. Tous droits réservés.

Ce produit ou document est protégé par un copyright et distribué avec des licences qui en restreignent l'utilisation, la copie, la distribution, et la décompilation. Aucune partie de ce produit ou document ne peut être reproduite sous aucune forme, par quelque moyen que ce soit, sans l'autorisation préalable et écrite de Sun et de ses bailleurs de licence, s'il y en a. Le logiciel détenu par des tiers, et qui comprend la technologie relative aux polices de caractères, est protégé par un copyright et licencié par des fournisseurs de Sun.

Des parties de ce produit pourront être dérivées des systèmes Berkeley BSD licenciés par l'Université de Californie. UNIX est une marque déposée aux Etats-Unis et dans d'autres pays et licenciée exclusivement par X/Open Company, Ltd. La notice suivante est applicable à Netscape Communicator™: Copyright 1995 Netscape Communications Corporation. Tous droits réservés.

Sun, Sun Microsystems, the Sun logo, AnswerBook2, docs.sun.com, SunSwift, SunVTS, FastEthernet, et Solaris sont des marques de fabrique ou des marques déposées, ou marques de service, de Sun Microsystems, Inc. aux Etats-Unis et dans d'autres pays. Toutes les marques SPARC sont utilisées sous licence et sont des marques de fabrique ou des marques déposées de SPARC International, Inc. aux Etats-Unis et dans d'autres pays. Les produits portant les marques SPARC sont basés sur une architecture développée par Sun Microsystems, Inc.

L'interface d'utilisation graphique OPEN LOOK et Sun™ a été développée par Sun Microsystems, Inc. pour ses utilisateurs et licenciés. Sun reconnaît les efforts de pionniers de Xerox pour la recherche et le développement du concept des interfaces d'utilisation visuelle ou graphique pour l'industrie de l'informatique. Sun détient une licence non exclusive de Xerox sur l'interface d'utilisation graphique Xerox, cette licence couvrant également les licenciés de Sun qui mettent en place l'interface d'utilisation graphique OPEN LOOK et qui en outre se conforment aux licences écrites de Sun.

CETTE PUBLICATION EST FOURNIE "EN L'ETAT" ET AUCUNE GARANTIE, EXPRESSE OU IMPLICITE, N'EST ACCORDEE, Y COMPRIS DES GARANTIES CONCERNANT LA VALEUR MARCHANDE, L'APTITUDE DE LA PUBLICATION A REpondre A UNE UTILISATION PARTICULIERE, OU LE FAIT QU'ELLE NE SOIT PAS CONTREFAISANTE DE PRODUIT DE TIERS. CE DENI DE GARANTIE NE S'APPLIQUERAIT PAS, DANS LA MESURE OU IL SERAIT TENU JURIDIQUEMENT NUL ET NON AVENU.



Regulatory Compliance Statements

Your Sun product is marked to indicate its compliance class:

- Federal Communications Commission (FCC) — USA
- Industry Canada Equipment Standard for Digital Equipment (ICES-003) - Canada
- Voluntary Control Council for Interference (VCCI) — Japan
- Bureau of Standards Metrology and Inspection (BSMI) — Taiwan

Please read the appropriate section that corresponds to the marking on your Sun product before attempting to install the product.

FCC Class A Notice

This device complies with Part 15 of the FCC Rules. Operation is subject to the following two conditions:

This device may not cause harmful interference.

1. This device must accept any interference received, including interference that may cause undesired operation.

Note: This equipment has been tested and found to comply with the limits for a Class A digital device, pursuant to Part 15 of the FCC Rules. These limits are designed to provide reasonable protection against harmful interference when the equipment is operated in a commercial environment. This equipment generates, uses, and can radiate radio frequency energy, and if it is not installed and used in accordance with the instruction manual, it may cause harmful interference to radio communications. Operation of this equipment in a residential area is likely to cause harmful interference, in which case the user will be required to correct the interference at his own expense.

Shielded Cables: Connections between the workstation and peripherals must be made using shielded cables to comply with FCC radio frequency emission limits. Networking connections can be made using unshielded twisted-pair (UTP) cables.

Modifications: Any modifications made to this device that are not approved by Sun Microsystems, Inc. may void the authority granted to the user by the FCC to operate this equipment.

FCC Class B Notice

This device complies with Part 15 of the FCC Rules. Operation is subject to the following two conditions:

This device may not cause harmful interference.

2. This device must accept any interference received, including interference that may cause undesired operation.

Note: This equipment has been tested and found to comply with the limits for a Class B digital device, pursuant to Part 15 of the FCC Rules. These limits are designed to provide reasonable protection against harmful interference in a residential installation. This equipment generates, uses and can radiate radio frequency energy and, if not installed and used in accordance with the instructions, may cause harmful interference to radio communications. However, there is no guarantee that interference will not occur in a particular installation. If this equipment does cause harmful interference to radio or television reception, which can be determined by turning the equipment off and on, the user is encouraged to try to correct the interference by one or more of the following measures:

- Reorient or relocate the receiving antenna.
- Increase the separation between the equipment and receiver.
- Connect the equipment into an outlet on a circuit different from that to which the receiver is connected.
- Consult the dealer or an experienced radio/television technician for help.

Shielded Cables: Connections between the workstation and peripherals must be made using shielded cables in order to maintain compliance with FCC radio frequency emission limits. Networking connections can be made using unshielded twisted pair (UTP) cables.

Modifications: Any modifications made to this device that are not approved by Sun Microsystems, Inc. may void the authority granted to the user by the FCC to operate this equipment.

ICES-003 Class A Notice - Avis NMB-003, Classe A

This Class A digital apparatus complies with Canadian ICES-003.

Cet appareil numérique de la classe A est conforme à la norme NMB-003 du Canada.

ICES-003 Class B Notice - Avis NMB-003, Classe B

This Class B digital apparatus complies with Canadian ICES-003.

Cet appareil numérique de la classe B est conforme à la norme NMB-003 du Canada.

VCCI 基準について

クラス A VCCI 基準について

クラス A VCCI の表示があるワークステーションおよびオプション製品は、クラス A 情報技術装置です。これらの製品には、下記の項目が該当します。

この装置は、情報処理装置等電波障害自主規制協議会 (VCCI) の基準に基づくクラス A 情報技術装置です。この装置を家庭環境で使用すると電波妨害を引き起こすことがあります。この場合には使用者が適切な対策を講ずるよう要求されることがあります。

クラス B VCCI 基準について

クラス B VCCI の表示  があるワークステーションおよびオプション製品は、クラス B 情報技術装置です。これらの製品には、下記の項目が該当します。

この装置は、情報処理装置等電波障害自主規制協議会 (VCCI) の基準に基づくクラス B 情報技術装置です。この装置は、家庭環境で使用することを目的としていますが、この装置がラジオやテレビジョン受信機に近接して使用されると、受信障害を引き起こすことがあります。取扱説明書に従って正しい取り扱いをしてください。

BSMI Class A Notice

The following statement is applicable to products shipped to Taiwan and marked as Class A on the product compliance label.

警告使用者：

這是甲類的資訊產品，在居住的環境中使用時，可能會造成射頻干擾，在這種情況下，使用者會被要求採取某些適當的對策。

Declaration of Conformity

Compliance Model Number: FC3UC
Product Name: Sun StorEdge CompactPCI Dual Fibre Channel Network Adapter

EMC

European Union

This equipment complies with the following requirements of the EMC Directive 89/336/EEC:

EN55022:1995/CISPR22:1997	Class A
EN550024:1998	4 kV (Direct), 8 kV (Air)
EN61000-4-2	3 V/m
EN61000-4-3	1.0 kV Power Lines, 0.5 kV Signal Lines
EN61000-4-4	1 kV Line-Line, 2 kV Line-Gnd Power Lines
EN61000-4-5	3 V
EN61000-4-6	3 A/m
EN61000-4-8	Pass
EN61000-4-11	Pass
EN61000-3-2:1995	Pass
EN61000-3-3:1995	Pass

Safety

This equipment complies with the following requirements of the Low Voltage Directive 73/23/EEC:

EC Type Examination Certificates:
EN60950:1992, 2nd Edition

Supplementary Information

This product was tested and complies with all the requirements for the CE Mark.

Dennis P. Symanski
Manager, Compliance Engineering
Sun Microsystems, Inc.
901 San Antonio Road, MPK15-102
Palo Alto, CA 94303-4900, USA

Tel: 650-786-3255
Fax: 650-786-3723

DATE

Peter Arkless
Quality Manager

Sun Microsystems Scotland, Limited
Springfield, Linlithgow
West Lothian, EH49 7LR
Scotland, United Kingdom

Tel: 0506-670000
Fax: 0506 760011

DATE

Contents

1. About the Sun StorEdge CompactPCI Dual Fibre Channel Network Adapter	1
Features	2
Hardware and Software Requirements	3
2. Installing and Extracting the Adapter	5
Preparing for the Installation	6
Tools and Equipment Needed	6
Contents of the Ship Kit	6
Determining the Type of Adapter Installation	6
Models of Hot Swap	7
Installing the Adapter	7
▼ To Prepare the System for a Cold Installation	8
▼ To Prepare the System for Hot Installation	8
▼ To Install the Adapter	9
Attaching the Adapter to the System	11
▼ To Attach the Adapter in a Hot Swap Environment	11
▼ To Power the System on After a Cold Installation	12
Extracting the Adapter	13
Determining the Type of Adapter Extraction	13

- ▼ To Extract the Adapter from a Hot Environment 13
- ▼ To Extract the Adapter from a Cold Environment 14
- Attaching Fibre-Optic Cables to the Host Adapter 15

3. Software Driver Installation and Install Verification Guide 19

Software Requirements 19

Device Drivers 19

Testing the Installation 20

SunVTS™ 20

SunVTS qlctest 20

▼ Testing Procedure 20

A. Specifications 23

Performance Specifications 23

Physical Characteristics 24

Power Requirements 24

Environmental Specifications 25

Figures

- FIGURE 1-1 Sun Dual Fibre Channel 3U Compact PCI Adapter 1
- FIGURE 2-1 Opening the Ejection Lever 9
- FIGURE 2-2 Closing the Ejection Lever 10
- FIGURE 2-3 Tightening the Ejection Lever Captive Screw 10
- FIGURE 2-4 Sun cPCI Dual Fibre Channel Host Adapter Dust Covers 15
- FIGURE 2-5 Connecting a Fiber Optic Cable to an OT Connector 16

Tables

TABLE 3-1	Sun VTS References	20
TABLE 3-2	qlctest Dependencies	20
TABLE A-1	Performance Specifications	23
TABLE A-2	Physical Characteristics	24
TABLE A-3	Power Requirements	24
TABLE A-4	Environmental Specifications	25

Preface

This manual describes how to install and use your Sun StorEdge CompactPCI Dual Fibre Channel Network Adapter.

The procedures in this manual assume that you are a system or network administrator experienced in installing similar hardware in a Solaris™ operating environment.

How This Book Is Organized

The document is organized as follows:

Chapter 1 “About the Sun StorEdge CompactPCI Dual Fibre Channel Network Adapter,” describes the hardware and software requirements for the adapter as well as the adapter features.

Chapter 2 “Installing and Extracting the Adapter,” tells you how to install the adapter into your system.

Chapter 3 “Software Driver Installation and Install Verification Guide,” explains how to verify that the adapter is functioning properly.

Appendix “Specifications,” lists the hardware specifications.

Using UNIX Commands

This document may not contain information on basic UNIX[®] commands and procedures such as shutting down the system, booting the system, and configuring devices.

See one or more of the following for this information:

- *Solaris Handbook for Sun Peripherals*
- AnswerBook2[™] online documentation for the Solaris[™] operating environment
- Other software documentation that you received with your system

Typographic Conventions

Typeface	Meaning	Examples
AaBbCc123	The names of commands, files, and directories; on-screen computer output	Edit your <code>.login</code> file. Use <code>ls -a</code> to list all files. % You have mail.
AaBbCc123	What you type, when contrasted with on-screen computer output	% su Password:
<i>AaBbCc123</i>	Book titles, new words or terms, words to be emphasized	Read Chapter 6 in the <i>User's Guide</i> . These are called <i>class</i> options. You <i>must</i> be superuser to do this.
	Command-line variable; replace with a real name or value	To delete a file, type <code>rm filename</code> .

Shell Prompts

Shell	Prompt
C shell	<i>machine_name%</i>
C shell superuser	<i>machine_name#</i>
Bourne shell and Korn shell	\$
Bourne shell and Korn shell superuser	#

Accessing Sun Documentation Online

The `docs.sun.comsm` web site enables you to access Sun technical documentation on the Web. You can browse the `docs.sun.com` archive or search for a specific book title or subject at:

`http://docs.sun.com`

Ordering Sun Documentation

Fatbrain.com, an Internet professional bookstore, stocks select product documentation from Sun Microsystems, Inc.

For a list of documents and how to order them, visit the Sun Documentation Center on Fatbrain.com at:

<http://www1.fatbrain.com/documentation/sun>

Sun Welcomes Your Comments

We are interested in improving our documentation and welcome your comments and suggestions. You can email your comments to us at:

docfeedback@sun.com

Please include the part number (816-0241-10) of your document in the subject line of your email.

About the Sun StorEdge CompactPCI Dual Fibre Channel Network Adapter

The Sun StorEdge CompactPCI Dual Fibre Channel Network Adapter offers two 1-Gbit Fibre Channel ports on a cPCI card.

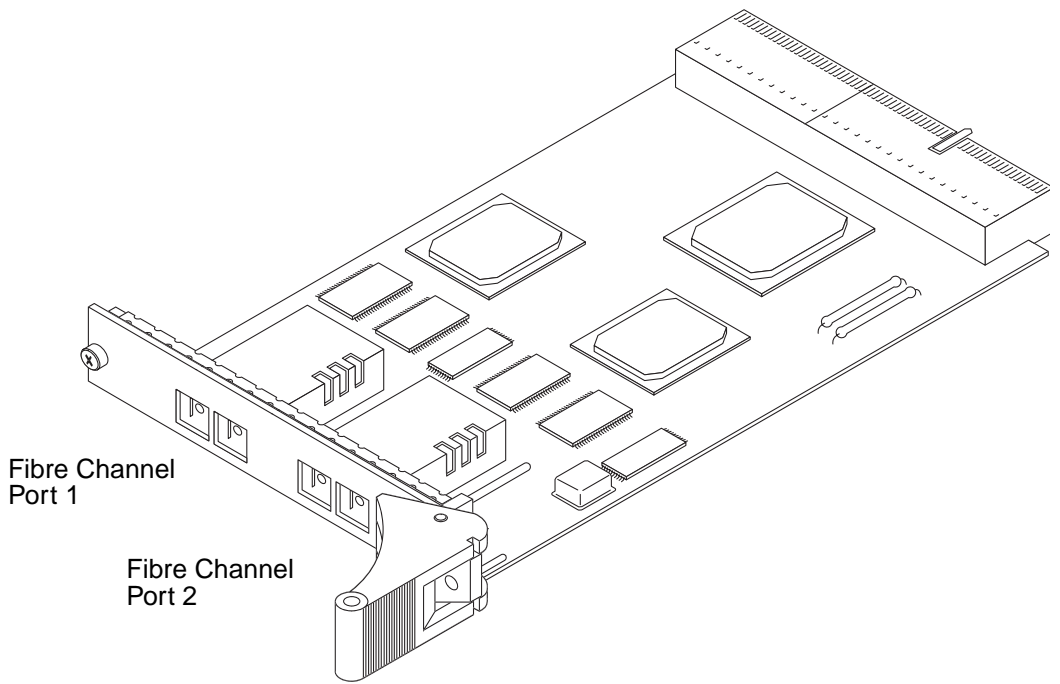

FIGURE 1-1 Sun Dual Fibre Channel 3U Compact PCI Adapter

Features

Following is a list of the Sun Dual Fibre Channel compactPCI (cPCI) adapter features:

CompactPCI

- Supports hot swap cPCI installation and removal
- Conforms to the cPCI specification, PICMG 2.0 D3.0
- Conforms to cPCI hot swap specification PICMG 2.1 R1.0

Fibre Channel

- Execution of multiple I/O control blocks from the host
- Reduced host intervention and interrupt overhead

FCAL Interface

- ANSI X3 T11-compliant
- FC-PH-3 Rev.9.2 compliant
- FC-AL-2 Rev.5.4 compliant
- FC-FLA Rev.2.7 compliant
- 2 ports, short wave, multi-mode fibre
 - 100 MBytes/s transfer rate per port
 - 126 devices (max.) per port
 - 300 meters for 62.5 micron fibre
 - 500 meters for 50 micron fibre

Hardware and Software Requirements

Before using the Sun StorEdge CompactPCI Dual Fibre Channel Network Adapter, make sure your system meets the following hardware and software requirements:

Hardware and Software	Requirements
Hardware Requirements	Sun systems with an available cPCI slot
Software Requirements	Solaris 8 operating environment
Firmware	OpenBoot™ PROM version 5.1 or greater
Peripherals Attached to PCI Adapter	All 1-Gbit optical FC devices
Fibre Channel Cables	Only standard cabling supported by Sun to ensure reliable FC interface connections

Installing and Extracting the Adapter

This chapter describes how to install and extract the Sun StorEdge CompactPCI Dual Fibre Channel Network Adapter.

This chapter contains the following sections:

- “Preparing for the Installation” on page 6
- “Installing the Adapter” on page 7
- “Extracting the Adapter” on page 13
- “Attaching Fibre-Optic Cables to the Host Adapter” on page 15

Note – Refer to your system installation or service manual for detailed instructions for the following tasks.

Preparing for the Installation

Before installing the adapter, prepare for the installation by assembling the appropriate tools, unpacking the ship kit, and selecting an I/O slot in the system.

Tools and Equipment Needed

You will need:

- Number 0 Phillips screwdriver
- Electrostatic discharge (ESD) mat (optional)

Contents of the Ship Kit

The ship kit should contain the following items:

- CompactPCI card
- Anti-static wrist strap
- This manual



Caution – Electrostatic discharge can damage the integrated circuits on the cards. Leave the cards in their anti-static envelopes until you are ready to install them into the system.

Determining the Type of Adapter Installation

The adapter is a hot-swappable component that can be installed into a hot-swap-compliant system without interrupting the operation of the system. The adapter can also be installed in a cold environment, where you power down the system before you install the adapter.

Determine whether you want to perform a hot swap installation of the adapter or a cold installation.

- In a hot swap installation, you can install the adapter while the system is running, without interrupting the operation of the server. Depending on the level of hot swap your server is running (full or basic), you may be required to enter software commands before and after the installation.

- In a cold installation, you must shut down the operating system and power down the system before installing the adapter. After the installation, you must power the system back on for the system to recognize the new adapter.

Note – This chapter describes the general procedure needed for either a hot swap or a cold swap installation. Because software commands and LED displays can differ for each server, refer to your server’s documentation for the appropriate installation procedures.

Models of Hot Swap

Hot swap, a key feature of the PCI Industrial Computer Manufacturers Group (PICMG) standard, means that a CompactPCI adapter that meets the PICMG standard can be reliably inserted into or extracted from a powered and operating CompactPCI platform without affecting the other functions of the platform. The standard also defines state transitions from the hardware and software connection processes that allow the card to be connected and configured.

The adapter supports two models of hot swap:

- Basic hot swap
- Full hot swap

The models can be explained by first defining the following processes:

- Hardware connection process—the electrical connection (and disconnection) of an I/O card.
- Software connection process—the software management by the operating system of the board (allocating/releasing resources, attaching/detaching device drivers, and so on).

In the basic hot swap model, the hardware connection process can be performed automatically by the hardware, while the software connection process requires operator assistance.

In the full hot swap model, both the hardware and the software connection process are performed automatically.

Installing the Adapter

This section contains the procedures required for installing the card in the server.

Note – This section provides a general overview of the tasks needed to prepare for either a hot or cold installation. For the exact procedures required for your system, refer to the documentation that shipped with your system.

▼ To Prepare the System for a Cold Installation

1. **Before shutting down the operating environment and halting the system, ensure that all significant application activity on the server has stopped.**
2. **Follow the appropriate procedures, as documented in the system's service manual, to shut down and halt the system.**

Refer to the system's documentation for the complete power down procedure.

3. **Press the power switch on the system's status panel to power down the system.**

Refer to the system's documentation for the location of the power switch.

4. **Verify that the system's power LED is off (unlit) indicating that the system is completely powered off.**

Once the system has been shut down and powered off, you can safely install the card.

▼ To Prepare the System for Hot Installation

- **Follow the appropriate procedures, as documented in the system's documentation, to prepare the system for a hot installation of the adapter.**

Refer to the system's documentation for the complete hot swap instructions.

1. **Type the following command:**

```
% cfgadm
```

Confirm that the intended slot can be identified as unconfigured on the list.

▼ To Install the Adapter

Note – Refer to the system service or administration guide for detailed instructions for following tasks.

1. Get the antistatic wrist strap from the ship kit.
2. Unwrap the first two folds of the wrist strap and wrap the adhesive side firmly against your wrist.
3. Peel the liner from the copper foil at the opposite end of the wrist strap and attach the copper end of the strap to a bare metal area on the front of the server.
4. Identify the slot number where you want to insert the adapter.
5. Remove the filler panel from the slot you selected.

Refer to the system's documentation for instructions on how to remove the filler panel.

6. Remove the card from its antistatic envelope and package and place it on the electrostatic discharge mat.

If an electrostatic discharge mat is not available, you can place the card on the antistatic envelope it was shipped in.

Before installing the card in the system, open the card's ejection lever (see FIGURE 2-1).

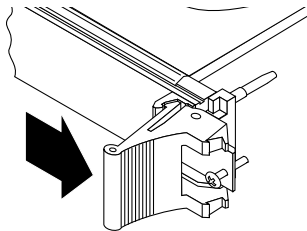

FIGURE 2-1 Opening the Ejection Lever

7. Pull back the ejection lever and slide the card into the cPCI slot.



Caution – Do not use excessive force when inserting the adapter into the cPCI slot. You may damage the adapter's connector or the pins on the backplane, causing permanent damage to the adapter or the system. If the adapter does not seat properly when you apply even pressure, remove it and carefully reinstall it.

- 8. Applying even pressure at both corners of the card, push the card until it is firmly seated in the slot.**

In a hot swap installation, when the card is properly seated and the physical connection is complete the blue LED lights up.

- 9. Push the ejection lever over the sprocket toward the card and into the locked position.**

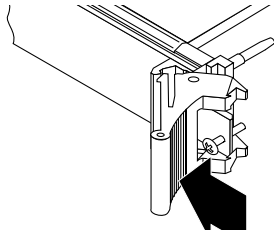

FIGURE 2-2 Closing the Ejection Lever

This locks the card into the slot and completes the hardware installation. In a hot installation, the blue LED should go off.

If the blue LED does not go off, it either means the system into which you inserted the card does not fully support the hot-swap feature or the card is not properly seated.

- 10. Using a No. 0 Phillips screwdriver, tighten the captive screws inside the card's ejection lever.**

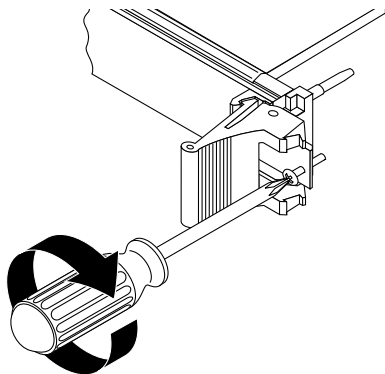

FIGURE 2-3 Tightening the Ejection Lever Captive Screw

- 11. Remove the wrist strap from the chassis and your wrist.**

12. **Check your system documentation for any additional actions that may be required to configure the system software for the newly inserted card.**

For example, in some systems you must type the following command:

```
% cfgadm -c configure attachment_point
```

This turns off the blue LED and initiates the software, which responds by configuring the system software for the newly inserted card.

Attaching the Adapter to the System

After installing the adapter, you must make the system recognize the new adapter and its Fibre Channel interfaces. The procedure for attaching the adapter to the system depends on whether you installed the adapter in a hot swap or cold environment.

If you performed a hot installation, see “To Attach the Adapter in a Hot Swap Environment” on page 11. If you powered down the system before installing the card, see “To Power the System on After a Cold Installation” on page 12.

▼ To Attach the Adapter in a Hot Swap Environment

1. **Follow the hot swap procedures for attaching an I/O card to the system in the system’s documentation.**

Refer to the system’s server or hardware installation manual for the attachment procedure specific to your system.

2. **On some systems, for example, you would log into the system console as superuser and identify the board slot number (attachment point).**

```
# cfgadm
```

3. **Plug the adapter in and engage the latch**

Check the hot swap LED on the adapter.

- If the adapter was installed correctly, the blue LED should be off.
- If the hot swap LED remains on (lit), the adapter was not installed correctly. Remove and reinstall the adapter to make sure it is seated correctly in the slot.

If you have to reinstall the card, be sure to follow the instructions outlined in your system's service manual for the removal and replacement of I/O cards.

4. Verify the adapter configuration:

```
# cfgadm
```

The slot number should show `Connected` and `Configured OK`

Refer to the system documentation for additional troubleshooting instructions.

▼ To Power the System on After a Cold Installation

1. **Before powering the system on, make sure that all the cables are connected (refer to “Attaching Fibre-Optic Cables to the Host Adapter” on page 15) and the peripheral devices are powered on.**

2. **Follow the appropriate procedures, as documented in the system's hardware installation manual, to power on the system.**

Refer to the system's documentation for the complete power on procedure.

3. **Check the hot swap LED on the adapter.**

- If the adapter was installed correctly, the blue LED should be off.
- If the hot swap LED remains on (lit), the adapter was not installed correctly. Remove and reinstall the adapter to make sure it is seated correctly in the slot.

If you have to reinstall the card, be sure to follow the instructions outlined in your system's service manual for the removal and replacement of I/O cards.

Refer to the system documentation for additional troubleshooting instructions.

4. **Verify that the system's power LED is on (lit), indicating that the system has completely powered on.**

Extracting the Adapter

The adapter is a hot swappable component that can be extracted from a hot-swap-compliant system without interrupting the operation of the system. The adapter can also be extracted from a cold environment, where you power down the system before you extract the adapter.

Determining the Type of Adapter Extraction

Determine whether you want to perform a hot extraction of the adapter or a cold extraction.

- In a hot swap extraction, you may be required to enter software commands before and after the extraction to detach the adapter from the system correctly.
- In a cold extraction, you must shut down the system's operating system and power down the system before extracting the adapter.

Note – The following procedures provide a general overview of the tasks needed to prepare for either a hot or cold extraction. For the specific procedures required for your system, refer to the documentation that shipped with your system.

▼ To Extract the Adapter from a Hot Environment

1. **As superuser, identify the cPCI card to be removed.**

You must know the slot number (attachment point ID).

```
# cfgadm
```

I/O assemblies are indicated by ". .sg-- . .". The attachment points (board slots) displayed are numbered starting with 0 at the system board side of the cPCI I/O assembly.

2. Detach (unconfigure) the cPCI card to be removed.

```
# cfgadm -c unconfigure attachment_point
```

Where *attachment_point* is *pcischxxx*.

3. Repeat the attachment point list to confirm the board detachment.

```
# cfgadm
```

4. Verify that the blue LED on the adapter is on.

The Removal OK LED on the I/O boat must change from green to amber to signal the unconfigured state. When the Removal OK LED is amber, it is safe to remove the cPCI card.

5. Depress the red release button at the ejector and pull the locking handle back.
6. Slide the card out of the cPCI slot.

▼ To Extract the Adapter from a Cold Environment

1. Before shutting down the operating environment and halting the system, ensure that all significant application activity on the server has stopped.
2. Follow the appropriate procedures, as documented in the system's service manual, to shut down and halt the system.

Refer to the system's documentation for the complete power down procedure.

3. Press the power switch on the system's status panel to power down the system.
Refer to the system's documentation for the location of the power switch.
4. Verify that the system's power LED is off (unlit) indicating that the system is completely powered off.

Once the system has been shut down and powered off, you can safely extract the card.

Attaching Fibre-Optic Cables to the Host Adapter

1. **Pull the two dust covers out of the 1x9 optical transceiver (OT) connectors** (FIGURE 2-4).

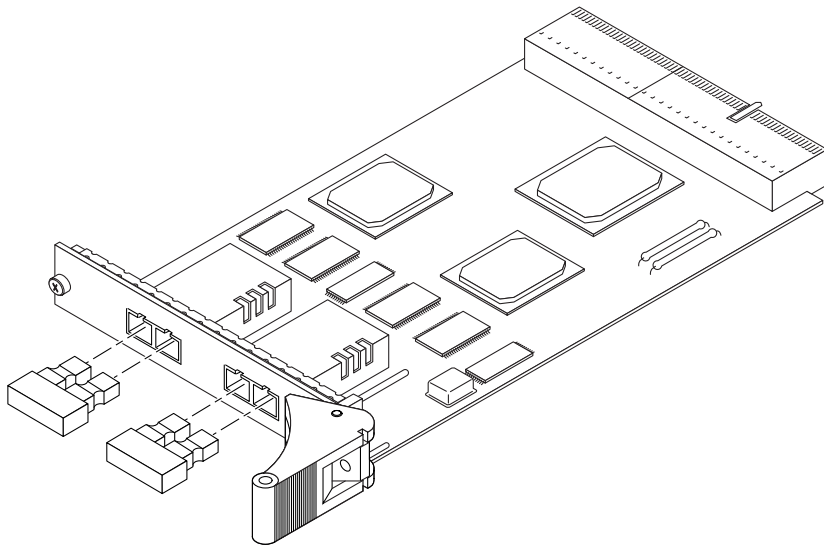

FIGURE 2-4 Sun cPCI Dual Fibre Channel Host Adapter Dust Covers

2. **Install the host adapter in the cPCI slot you have chosen.**
Installation details vary for each system. Refer to your system documentation for specific instructions.
3. **Reassemble the system.**
Refer to your system documentation for specific instructions.
4. **Disconnect the wrist strap.**
5. **Push the fiber optic cable connector into the OT connector until you hear a click** (FIGURE 2-5).



Caution – Fiber optic cables have keyed connectors; they can only be inserted into OT connectors as shown in FIGURE 2-5.

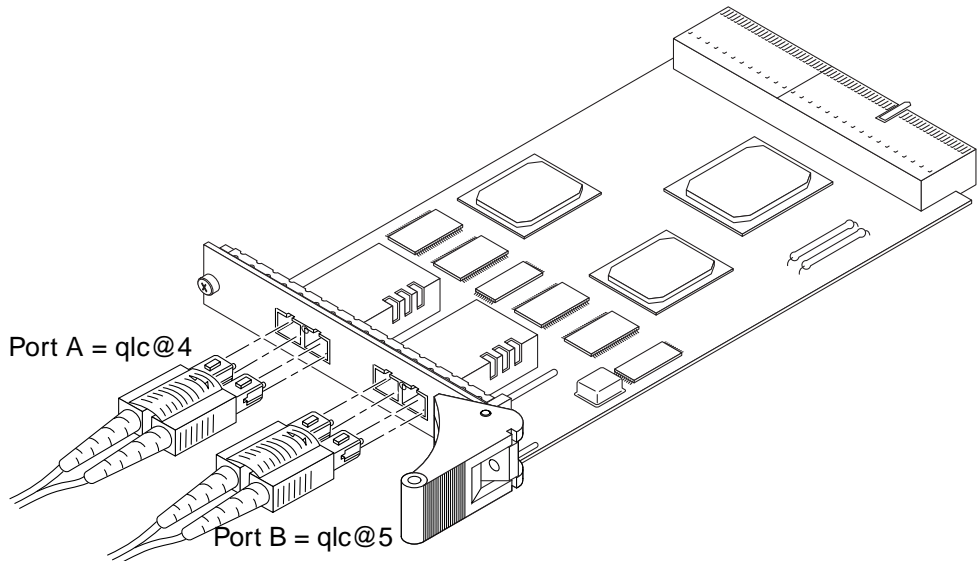

FIGURE 2-5 Connecting a Fiber Optic Cable to an OT Connector

6. Verify the installation by typing the `show-devs` command after the OK prompt:

```
>OK show-devs
```

You will see output similar to that in CODE EXAMPLE 2-1.

CODE EXAMPLE 2-1 show-devs Output

```
{3} ok show-devs
/ (gptwo)
/ssm@0,0 (gptwo)
/ssm@0,0/pci@1d,600000 (pci)
/ssm@0,0/pci@1d,700000 (pci)
/ssm@0,0/sghsc@1c,700000 (sghsc)
/ssm@0,0/pci@1c,600000 (pci)
/ssm@0,0/pci@1c,600000/pci@1 (pci)
/ssm@0,0/pci@1c,600000/pci@1/SUNW,isptwo@4 (scsi)
/ssm@0,0/pci@1c,600000/pci@1/SUNW,isptwo@4/st (byte)
/ssm@0,0/pci@1c,600000/pci@1/SUNW,isptwo@4/sd (block)
/ssm@0,0/pci@1c,600000/pci@1/SUNW,hme@0,1 (network)
/ssm@0,0/pci@1c,600000/pci@1/pci108e,1000@0
/ssm@0,0/pci@1c,700000 (pci)
```

CODE EXAMPLE 2-1 show-devs Output (Continued)

```
/ssm@0,0/pci@1c,700000/bootbus-controller@4
/ssm@0,0/pci@19,600000 (pci)
/ssm@0,0/pci@19,700000 (pci)
/ssm@0,0/pci@19,700000/pci@2 (pci)
/ssm@0,0/pci@19,700000/pci@2/SUNW,isptwo@5 (scsi)
/ssm@0,0/pci@19,700000/pci@2/SUNW,isptwo@5/st (byte)
/ssm@0,0/pci@19,700000/pci@2/SUNW,isptwo@5/sd (block)
/ssm@0,0/pci@19,700000/pci@2/SUNW,isptwo@4 (scsi)
/ssm@0,0/pci@19,700000/pci@2/SUNW,isptwo@4/st (byte)
/ssm@0,0/pci@19,700000/pci@2/SUNW,isptwo@4/sd (block)
/ssm@0,0/sghsc@18,700000 (sghsc)
/ssm@0,0/pci@18,600000 (pci)
/ssm@0,0/pci@18,700000 (pci)
/ssm@0,0/pci@18,700000/pci@2 (pci)
/ssm@0,0/pci@18,700000/pci@2/SUNW,qlc@5 (scsi-fcp)
/ssm@0,0/pci@18,700000/pci@2/SUNW,qlc@5/fp@0,0 (fp)
/ssm@0,0/pci@18,700000/pci@2/SUNW,qlc@5/fp@0,0/disk (block)
/ssm@0,0/pci@18,700000/pci@2/SUNW,qlc@4 (scsi-fcp)
/ssm@0,0/pci@18,700000/pci@2/SUNW,qlc@4/fp@0,0 (fp)
/ssm@0,0/pci@18,700000/pci@2/SUNW,qlc@4/fp@0,0/disk (block)
/ssm@0,0/pci@18,700000/bootbus-controller@4
/ssm@0,0/memory-controller@3,400000 (memory-controller)
/ssm@0,0/SUNW,UltraSPARC-III@3,0 (cpu)
/ssm@0,0/memory-controller@2,400000 (memory-controller)
/ssm@0,0/SUNW,UltraSPARC-III@2,0 (cpu)
/ssm@0,0/memory-controller@0,400000 (memory-controller)
/ssm@0,0/SUNW,UltraSPARC-III@0,0 (cpu)
/todsg (tod)
/sgcn (serial)
/failsafe (serial)
/virtual-memory (virtual-memory)
/memory@0,0 (memory)
/packages
/packages/ufs-file-system
/packages/SUNW,builtin-drivers
/packages/obp-tftp
/packages/terminal-emulator
/packages/disk-label
/packages/deblocker
/chosen
/options
/aliases
```

CODE EXAMPLE 2-1 show-devs Output (*Continued*)

```
/openprom
/openprom/client-services
{3} ok
```

Note the **boldface** type; it indicates the cPCI board paths.

To display the Fibre Channel devices connected to a specific port on the host adapter, use the `select-dev` command to select the port, then `show-children` to display the connected devices.

CODE EXAMPLE 2-2 show-children output

```
/ssm@0,0/pci@18,600000 (pci)
/ssm@0,0/pci@18,700000 (pci)
/ssm@0,0/pci@18,700000/pci@2 (pci)
/ssm@0,0/pci@18,700000/pci@2/SUNW,qlc@5 (scsi-fcp)
/ssm@0,0/pci@18,700000/pci@2/SUNW,qlc@5/fp@0,0 (fp)
/ssm@0,0/pci@18,700000/pci@2/SUNW,qlc@5/fp@0,0/disk (block)
/ssm@0,0/pci@18,700000/pci@2/SUNW,qlc@4 (scsi-fcp)
/ssm@0,0/pci@18,700000/pci@2/SUNW,qlc@4/fp@0,0 (fp)
/ssm@0,0/pci@18,700000/pci@2/SUNW,qlc@4/fp@0,0/disk (block)
```

Use the "select-dev" and "show-children" commands to show Fibre Channel devices attached to a particular port of the host adapter.

```
{0} ok " /ssm@0,0/pci@18,700000/pci@2/SUNW,qlc@5" select-dev
{0} ok show-children
LiD HA LUN --- Port WWN --- ----- Disk description -----
4d 4d 0 5080020000037ce3 SUN SENA 1.09
44 44 0 220000203718b391 SEAGATE ST318203FSUN18G 034A
5d 5d 0 5080020000037ce4 SUN SENA 1.09
{0} ok
```

Software Driver Installation and Install Verification Guide

This chapter gives you information that is necessary for you to use the Sun StorEdge CompactPCI Dual Fibre Channel Network Adapter in a system.

Software Requirements

Device Drivers

To support the device drivers for the Sun StorEdge CompactPCI Dual Fibre Channel Network Adapter, you must have the Solaris operating environment 8 4/01 or later release installed in your system.

- Once installed, the boards will have device paths similar to
`/ssm@0,0/pci@18,700000/pci@2/SUNW,qlc@5`
- Under these nodes, there will be one instance of the `fp` driver that has a device node similar to:
`/ssm@0,0/pci@18,700000/pci@2/SUNW,qlc@5/fp@0,0`
- `fp` driver also has a `devctl` node for administrative use with a name similar to
`/ssm@0,0/pci@18,700000/pci@2/SUNW,qlc@5/fp@0,0:devctl`
- For devices found, the nodes are created depending on the WWN of the device. For a WWN of 2100002037182670, the device path is similar to
`ssm@0,0/pci@18,700000/pci@2/SUNW,qlc@5/fp@0,0`
- Go to the <http://docs.sun.com> Web site, click Storage, then StorEdge, and read the *Sun StorEdge cPCI Dual Fibre Channel Host Adapter Product Notes* to obtain software patch IDs.
- The Fibre Channel transport device driver patches are at
<http://sunsolve.Sun.COM>

Testing the Installation

SunVTS™

Refer to the SunVTS documents in TABLE 3-1.

TABLE 3-1 Sun VTS References

Application	Title	Part Number
Diagnostic Testing	<i>Sun VTS 4.3 User's Guide</i>	
	<i>Sun VTS 4.3 Test Reference Manual</i>	

SunVTS is a diagnostic program that exercises your system to verify the functionality, reliability, and configuration of your host adapter. Install both the 32- and 64-bit versions of SunVTS.

SunVTS qlctest

Install SunVTS 4.3, which is bundled with the Solaris 8 4/01 Supplement CD.

TABLE 3-2 qlctest Dependencies

SunVTS Release	qlctest Package
4.3	SUNWvtsqc

▼ Testing Procedure

1. To invoke SunVTS locally on a system running CDE, type the following as `root`:

```
# cd /opt/SUNWvts/bin
# ./sunvts
```

2. From the SunVTS menus select the following:

- a. **Select devices** None **and select** intervention.
- b. **Select mode** Functional test.
- c. **Select** HostAdapters qlcx **where x is the qlc # of the qlc port you want to run this test against.**
- d. **If you want to run the external loopback test, place a loopback plug into the qlc port that you want to test.**
If you do not have an external loopback plug, you can make one by taking apart a fiber cable and plug the same cable into the transmitter and receiver of the qlc port.
- e. **Right click on the qlc test and select** Test Parameter Options.
- f. **Enable the** External Loopback Test.

Note – If you do not use a loopback plug, you can connect the qlc port to storage devices. In such a case, you will be testing both the qlc and the entire fiber loop.

- g. **Select** Start **to start the test.**

Note – If you select only the external loopback test, the different version diagnostic tests will not be run and the delay time between tests will be set to zero. This is a good way to test your fiber loop if you leave the qlc port attached to storage devices.

Specifications

Performance Specifications

TABLE A-1 Performance Specifications

Feature	Specification
PCI clock	33 MHz max.
PCI data burst Transfer Rate	264 MB/sec. burst rate
FC-AL Transfer Rate payload	100 MBytes/sec. (per port)
PCI Data/Address Lines	AD63-0
Fibre channel	Fibre optic media, short wave
Number of FC ports	2

Physical Characteristics

TABLE A-2 Physical Characteristics

Dimension	Measurement
Length	160 mm
Width	100 mm
Height (not including PCB)	
• Primary component side	13.40 mm (max.)
• Back component side	1.52 mm (max.)
Weight	200 grams (max.)

Power Requirements

TABLE A-3 Power Requirements

Specification	Measurement	Maximum Ripple
Maximum power consumption	15 Watts	
3.3v (+5/-3%) supply current	4.5A max	50 mV

Environmental Specifications

TABLE A-4 Environmental Specifications

Condition	Operating Specification	Storage Specification
Temperature	0 to 55 C (+32 to +131 F)	-40 to +65 C (-40 to +149 F)
Relative humidity	5 to 95% non-condensing (45 C, wet bulb temperature)	0 to 95% non-condensing 10 C/hour
Altitude	-1000 to +15,000 feet	-1000 to + 50,000 feet
Shock	10g, 1/2 sine wave, 11 msec	60g, 1/2 sine wave, 11 msec
Vibration, peak to peak displacement	0.005 in. max (5 to 32 Hz)	0.1 in. max (5 to 17 Hz)
Vibration, peak acceleration	0.25g (5 to 500 Hz) (Sweep Rate = 1 octave/min.)	0.25g (5 to 500 Hz) (Sweep Rate = 1 octave/min.)

Index

A

- adapter
 - attaching, 11
 - hot swap, 11
 - extraction, 5
 - features, 2
 - illustration, 1
 - installation, 5
 - installation type, 6
- adapter extraction, 13
- adapter insertion, 9
- attaching the adapter, 11

B

- basic hot swap, 7
- blue LED, 10

C

- cold extraction, 13, 14
- cold installation, 7, 12
 - preparation for, 8

E

- ejection lever, 9, 10
- environmental specifications, 25
- extracting the adapter, 5, 13

- extraction
 - cold, 13, 14

F

- features, 2
 - cPCI, 2
 - FCAL Interface, 2
 - Fibre Channel, 2
- fp driver, 19
- full hot swap, 7

H

- hardware
 - requirements, 3
- host adapter, attaching fibre-optic cables to, 15
- hot swap, 7
 - adapter attachment, 11
 - basic, 7
 - cPCI installation, 2
 - cPCI removal, 2
 - extraction, 13
 - full, 7
 - installation, 6, 8
 - models, 7
- hot swap installation
 - preparation for, 8

I

- inserting the adapter, 9
- installation
 - adapter, 5, 9
 - hot swap, 6
 - software driver, 19
- installation verification, 19

O

- OpenBoot PROM
 - requirements, 3

P

- PCI
 - connector, 1
- PCI Industrial Computer Manufacturers Group (PICMG), 7
- physical characteristics, 24
- power requirements, 24

Q

- qlctest, 20

R

- requirements
 - attached peripherals, 3
 - firmware, 3
 - hardware, 3
 - OpenBoot PROM, 3
 - software, 3

S

- select-dev, 18
- ship kit contents, 6
- show-children, 18
- showdev output, 16
- show-devs, 16

- software
 - requirements, 3
- software driver installation, 19
- specifications
 - environmental, 25
 - performance, 23
 - physical characteristics, 24
- SunVTS, 20
- system power on after cold install, 12

T

- tools, 6

W

- wrist strap, 9, 10